

C8060 CAM LOCK

- 5 DISC TUMBLER
- 90 OR 180 CAM TURN
- 1 3/4" CYLINDER LENGTH

180° CAM TURN

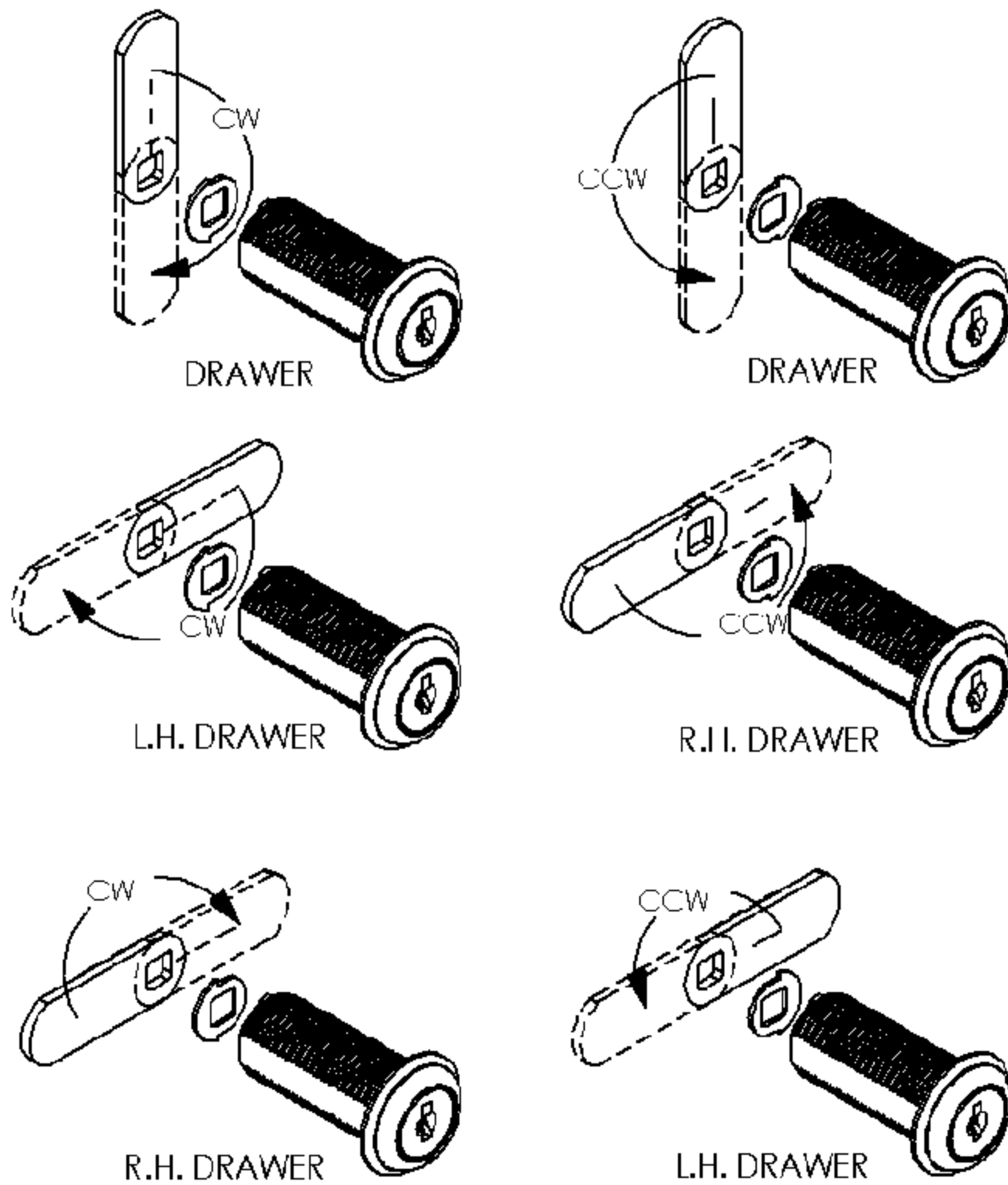

90° CAM TURN

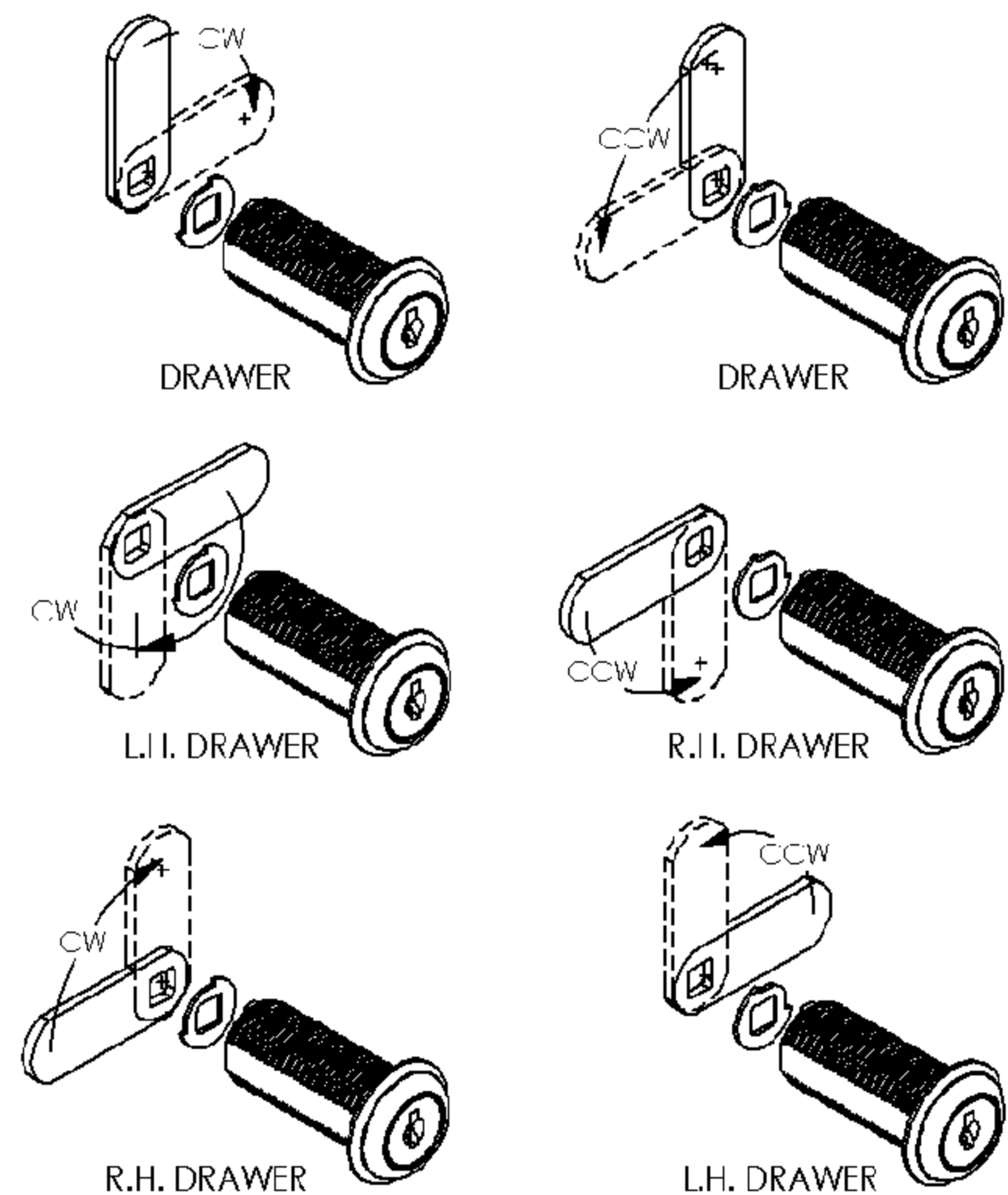

SOLID LINE SHOWS LOCKED POSITION

CYLINDER MOUNTING HOLES

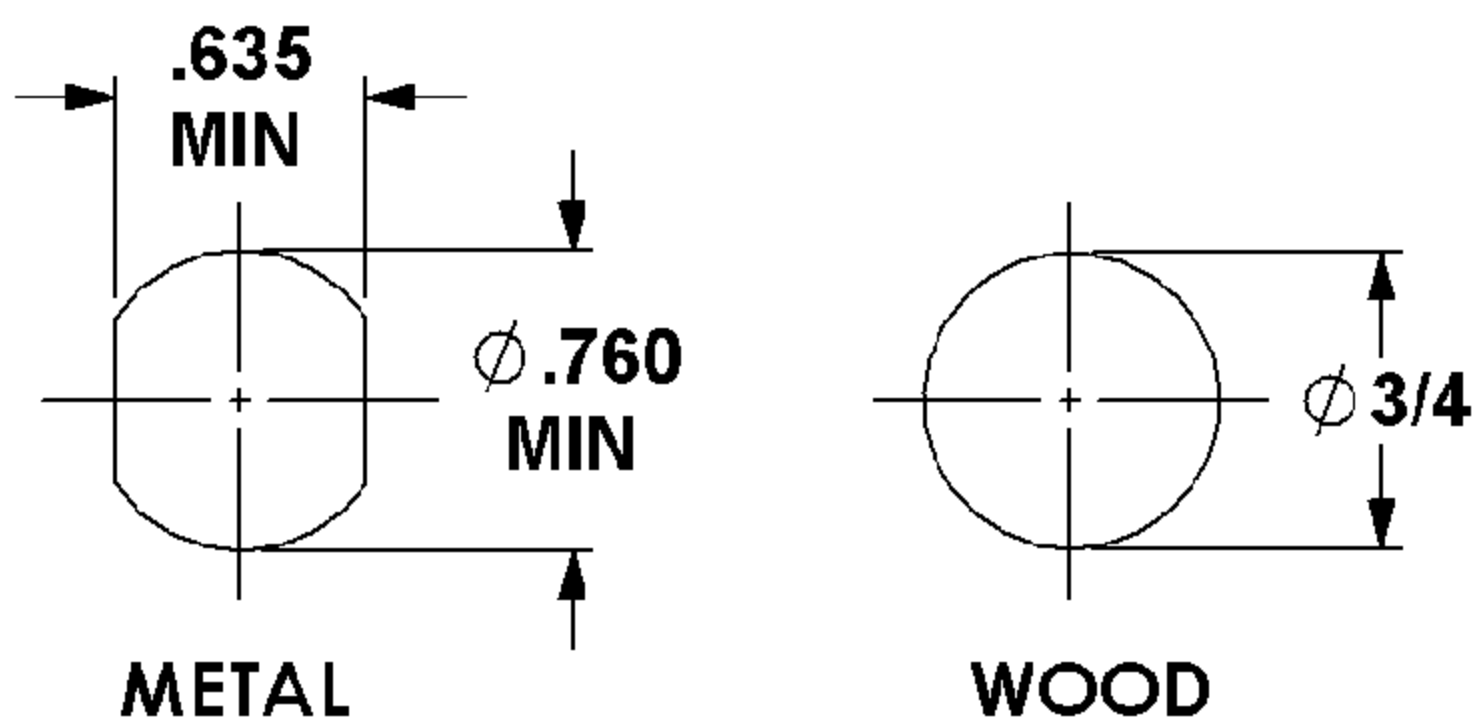

NOTE: DO NOT USE SPUR WASHER WITH METAL DOOR OR DRAWER

