



**WÜRTH**

**WÜRTH LOUIS  
AND COMPANY**



*Rhino*

**WORKOUT  
WEEK 2024**

**CONTENTS**

- Limited Edition Multi-Tool ..... 2
- Bumpers & Panel Spacers..... 3
- Screws and Bits ..... 4 - 8
- Pneumatic Fasteners and  
Pinner/Bradder..... 9
- Random Orbit Sander..... 10 - 11
- Sanding Discs ..... 12
- Sanding Sponges..... 13
- Foam Sealant & Joint Compound ..... 14
- Putty and Rags..... 15
- Mixing Cups, Strainers and Stain Pads... 16
- Hand Cleaner, Gloves and PPE ..... 17 - 21
- Tapes..... 22 - 24
- Furniture Pads & Dollies ..... 24
- Cleaners & Lubricants ..... 25
- Screwdriver/Worklight Kit..... 26



# CONNECTED WITH A GOOD CAUSE!

**Würth supports UNICEF by donating a part of the proceeds of RW WORKOUT Week to a UNICEF program.\***

\*UNICEF does not endorse any company, brand, product or service.



## 2024 Limited Edition Multi-Tool With Case

- Multi-tool in the exclusive Würth design with case
- All tools can be securely locked in position
- The pliers and 8 tools provides 15 functions
- Stainless steel design
- Size 102 x 39 x 23 mm

Item #	Price per Each
WR0715662024	<b>\$39.99</b>

**LIMITED TO STOCK ON HAND!**





## Würth Bumpers

- Easy "Peel-Off" & "Quick Stick"
- Vibration and Shock Dampening
- Non-Staining and Non-Marring
- Crack-Resistant and Resilient
- RoHS Compliant

Item #	Color	Size	Bumpers per Sheet	Sheets per Box	Bumpers per Box	Price per Sheet	
<b>Hemispherical</b>							
A	WRBS02-CLR	Clear	0.437" Dia x 0.2"H	50	100	5,000	<b>\$2.29</b>
	WRBS12-CLR	Clear	0.375" Dia x 0.15"H	50	144	7,200	<b>\$2.29</b>
	WRBS07-CLR	Clear	0.312" Dia x 0.085"H	75	72	5,400	<b>\$2.29</b>
<b>Specialty</b>							
B	WRBS33-CLR	Clear	0.5" Dia x 0.14"H	50	100	5,000	<b>\$2.29</b>
	WRBS58-CLR	Clear	0.5" Dia x 0.2"H	50	100	5,000	<b>\$2.09</b>
<b>Cylindrical</b>							
C	WRBS01-CLR	Clear	0.5" Dia x 0.14"H	50	100	5,000	<b>\$1.99</b>
	WRBS06-CLR	Clear	0.5" Dia x 0.25"H	50	100	5,000	<b>\$2.29</b>
	WRBS34-CLR	Clear	0.4" Dia x 0.125"H	40	154	6,160	<b>\$1.69</b>
	WRBS67-CLR	Clear	0.375" Dia x 0.19"H	50	145	7,250	<b>\$2.09</b>



## Würth Panel Spacers

- No Oil, Carbon Black or Phthalates
- Eliminate panel rattle and cracking glue joints
- Absolutely no bleeding into your panel door
- .270" diameter, best for use in 1/4" groove
- Recommended minimum spacing is 3/16" (8 - 10 spacers per 5 panel door)

\* If you are currently using another style of panel spacer with automatic insertion, make sure you run some isopropyl alcohol through to remove any talc or oil residue in the channel.

Item #	Bag Qty	Price per Bag
WR0683135800-1M	1,000	<b>\$18.99</b>
WR0683135800-5M	5,000	<b>\$88.95</b>

**\* Perfect for automatic insertion - no talc needed!**

# THE NEXT GENERATION

# ASSY® 4

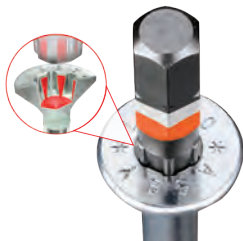

### RW 20 DRIVE BIT:

- Deep precision fit with larger contact surface in the head of the screw - no wobbling
- Prolonged bit life
- One size fits all
- Bit included in every box



### POWER THREAD:

- Smooth thread start ensures optimized piercing and fast biting of the screw
- New thread reduces screw-in force and minimizes friction caused by screw rotation
- Reinforced thread flank provides higher power transmission in hardwoods



### POINT:

- New point design displaces the wood fibre rather than cutting
- Decreases dynamic friction, increases static friction
- Improved initial start due to decreased thread height and pitch

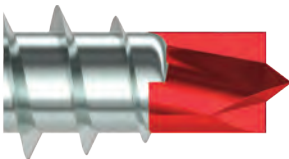

### DRILLING POINT (ASSY® Plus 4 only):

- Drilling tip features sharp cutting edges and effective chip removal preventing risk of splitting
- Center point prevents slipping, even on hard surfaces such as laminate and melamine
- Fast biting thanks to smooth start of thread



### MILLING POCKETS (ASSY® CSMP 4 and ASSY® Plus 4 only):

- Increased number of milling pockets improves quality of countersink
- Clean countersinking of the head in laminates, hardwood and softwood due to high milling performance and chip collection



### PACKAGING:

- RW bit is included in each box

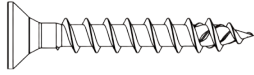
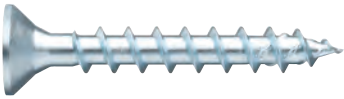

### ASSY® 4 Fittings Screw

- Full-thread screw for fastening fittings or cabinet connectors in wood or wooden panels
- Uses RW 20 Drive Bit (WR06147020)
- Box quantities as shown below
- Sold in full box quantities

**RW Bit Included  
in each box**

Length X Gauge	Item #	Box Qty	Price per Box
5/8" x 6	WR019003516	1,000	<b>\$42.30</b>
3/4" x 6	WR019003520	1,000	<b>\$44.34</b>

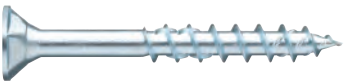

### ASSY® CSMP 4 Assembly Screw

- Universal partial-thread screw for fast, gap-free fastening of wood-wood connections
- Uses RW 20 Drive Bit (WR06147020)
- Box quantities as shown below
- Sold in full box quantities

**RW Bit Included  
in each box**

Length X Gauge	Item #	Box Qty	Price per Box
1" x 8	WR019014025	1,000	<b>\$41.54</b>
1-3/16" x 8	WR019014030	500	<b>\$21.50</b>
1-3/8" x 8	WR019014035	500	<b>\$23.50</b>
1-9/16" x 8	WR019014040	500	<b>\$26.41</b>

Length X Gauge	Item #	Box Qty	Price per Box
1-3/4" x 8	WR019014045	500	<b>\$28.50</b>
2" x 8	WR019014050	500	<b>\$29.00</b>
2-3/8" x 8	WR019014060	250	<b>\$15.25</b>
2-3/4" x 8	WR019014070	200	<b>\$16.40</b>

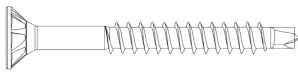
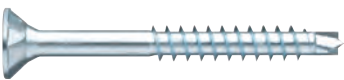

### ASSY® Plus 4 Assembly Screw

- Especially suitable for cabinet assembly when close to the edges of different materials - eliminating having to pre-drill in a separate step
- Uses RW 20 Drive Bit (WR06147020)
- Box quantities as shown below
- Sold in full box quantities

**RW Bit Included  
in each box**

Length X Gauge	Item #	Box Qty	Price per Box
1" x 8	WR017810425	1,000	<b>\$48.75</b>
1-3/16" x 8	WR017810430	500	<b>\$24.55</b>
1-3/8" x 8	WR017810435	500	<b>\$25.07</b>
1-9/16" x 8	WR017811440	500	<b>\$26.50</b>
1-3/4" x 8	WR017811445	500	<b>\$33.00</b>



Length X Gauge	Item #	Box Qty	Price per Box
2" x 8	WR017810450	500	<b>\$34.21</b>
2-3/8" x 8	WR017810460	250	<b>\$22.00</b>
2-3/4" x 8	WR017810470	200	<b>\$17.40</b>
3-1/8" x 9	WR0178104580	200	<b>\$26.60</b>



## Flat Head Square Drive, Coarse Thread With Nibs, Type I7 Auger Point

- 1" are threaded fully - all other sizes are threaded 2/3's from bottom of the screw
  - Case hardened finishes listed on right
  - #2 Square Drive bits
  - Box quantities as shown below
- Sold in full boxes only



Size	Minibox 			Bucket 			Case 		
	Item #	Box Qty	Price per Mini-box	Item #	Bucket Qty	Price per Bucket	Item #	Case Qty	Price per Case
<b>Case Hardened, Black Oxidized Finish</b>									
1" x 8	WUWS8X1FCSBNPT/L37100	1,000	\$16.63	WUWST8X100FCSTNPB/LT37120	7,000	\$108.64	WUWS8X1FCSBNPB/L37120	11,000	\$160.27
1-1/4" x 8	WUWS8X114FCSBNPT/L37140	1,000	\$18.33	WUWST8X114FCSTNPB/LT37160	5,000	\$84.95	WUWS8X114FCSBNPB/L37160	9,000	\$131.22
1-1/2" x 8	WUWS8X112FCSBNPT/L37180	1,000	\$21.52	WUWST8X112FCSTNPB/LT37200	5,000	\$95.05	WUWS8X112FCSBNPB/L37200	7,000	\$122.15
1-5/8" x 8	WUWS8X158FCSBNPT/L37220	1,000	\$22.98	WUWST8X158FCSTNPB/LT37240	3,500	\$70.39	WUWS8X158FCSBNPB/L37240	5,500	\$103.02
1-3/4" X 8	WUWS8X134FSCBT/L37260	1,000	\$24.92	-	-	-	-	-	-
2" x 8	WUWS8X2FCSBNPT/L37280	1,000	\$26.63	-	-	-	WUWS8X2FCSBNPB/L37300	4,000	\$79.12
2-1/4" x 8	WUWS8X214FSCBT/L37305	1,000	\$32.43	WUWST8X214FCSTNPB/LT37310	3,000	\$75.65	-	-	-
2-1/2" x 8	WUWS8X212FCSBNPT/L37340	1,000	\$33.74	WUWST8X212FCSTNPB/LT37350	2,500	\$79.03	WUWS8X212FCSBNPB/L37350	2,500	\$73.00
3" x 8	WUWS8X3FCSBNPT/L37380	1,000	\$41.14	WUWST8X300FCSTNPB/LT37390	2,000	\$72.36	WUWS8X3FCSBNPB/L37390	2,000	\$66.28
<b>Case Hardened, Zinc Finish</b>									
1" x 8	WUWS8X1FCSZNP/L31600	1,000	\$16.82	WUWST8X100FCSZNPB/LT31700	7,000	\$111.58	WUWS8X1FCSZNPB/L31700	11,000	\$158.73
1-1/4" x 8	WUWS8X114FCSZNP/L31800	1,000	\$18.27	WUWST8X114FCSZNPB/LT31900	5,000	\$84.40	WUWS8X114FCSZNPB/L31900	9,000	\$130.41
1-1/2" x 8	WUWS8X112FCSZNP/L38800	1,000	\$21.49	WUWST8X112FCSZNPB/LT38900	5,000	\$102.25	WUWS8X112FCSZNPB/L38900	7,000	\$133.91
1-5/8" x 8	WUWS8X158FCSZNP/L39000	1,000	\$24.86	WUWST8X158FCSZNPB/LT39100	3,500	\$76.88	WUWS8X158FCSZNPB/L39100	5,500	\$109.67
1-3/4" X 8	WUWS8X134FSCZT/L39110	1,000	\$29.48	-	-	-	WUWS8X134FSCZB/L39120	4,800	\$130.80
2" x 8	WUWS8X2FCSZNP/L39200	1,000	\$27.02	WUWST8X200FCSZNPB/LT39300	3,000	\$61.56	WUWS8X2FCSZNPB/L39300	4,000	\$77.44
2-1/4" x 8	WUWS8X214FCSZNP/L39400	1,000	\$34.70	WUWST8X214FCSZNPB/LT39500	2,500	\$84.73	-	-	-
2-1/2" x 8	WUWS8X212FCSZNP/L39710	1,000	\$33.38	WUWST8X212FCSZNPB/LT39715	2,500	\$78.83	WUWS8X212FCSZNPB/L39715	2,500	\$71.48
3" x 8	WUWS8X3FCSZNP/L39800	1,000	\$40.58	WUWST8X300FCSZNPB/LT39900	2,000	\$76.78	WUWS8X3FCSZNPB/L39900	2,000	\$68.88

## Würth Workout Week 2024

### Würth Screw Jar Program

- Includes the most popular size selections of our **TurboThread** and **PocketMaster** Screws
- Screws are conveniently packaged in a plastic re-sealable jar
- Convenient for job sites and install trucks - no more cardboard boxes or cases of screws to haul around
- Flip up carrying handle for easy movement around the shop or job site



**\$18.49**  
Per Jar  
Any Size & Each Jar  
Includes a **FREE**  
2" Drive Bit!

### TurboThread Screws, Recex (Combo) Drive

- Use in all wood working applications: assembly, face frame, slides, hinges and hardware
- Greater holding power than standard Type 17
- Case hardened, lubricated
- Uses #2 Square Drive bits to insert; #2 Phillips Drive bits can be used for after market adjustment



**Patented serrated tooth TurboThread allows for quick starting, reduced splitting, and less drive torque**

Size	Flat Head with Nibs		Round Washer	
	Item #	Jar Qty	Item #	Jar Qty
1" x 8	-	-	WU34750-JAR	500
1-1/4" x 8	WU32550-JAR	500	WU35150-JAR	500
1-1/2" x 8	WU32950-JAR	500	WU35550-JAR	250
2" x 8	WU33350-JAR	250	WU35950-JAR	250
2-1/2" x 8	WU33750-JAR	250	WU36350-JAR	125
3" x 8	-	-	WU36705-JAR	125

### PocketMaster Face Frame Screws, Square Drive

- **50% Longer Type-17** - Cuts better and splits less
- **45% Reduction of Splitting, Cracking and Bursting** - Less splitting = more efficient production and less waste
- **30% Greater Holding Power & Pull-Out Values** - Holds and pulls joints tighter together
- **60% Less Driving Torque with no driver bit slippage due to the #2 Square Drive** - Easier to drive and eliminates driver bit cam-out



Size	Item #	Jar Qty
1-1/4" x 7	WU17150-JAR	500
1-1/2" x 7	WU17350-JAR	500

### Drive and Insert Bits

- Manufactured for the perfect wobble free fit with Würth screws



Item #	Type	Length	Price per Each
LCTBS2X1RS	#2 Square	1"	<b>\$0.99</b>
WU90220	#2 Square	2"	<b>\$1.24</b>
LCTBS2X6RS	#2 Square	6"	<b>\$1.75</b>



## Flat Head Phillips Drive, Coarse Thread Hardware Screws

- Case hardened, finishes listed below
- Uses #2 Phillips Drive bits
- Box quantities as shown below. Sold in full boxes only

Length x Gauge	Finish	Mini Box Qty	Item #	Quick Code	Price per Box	Case Qty	Item #	Quick Code	Price per Case
5/8" x 6	Zinc	1,000	WUMS6X58FCPZT	L42300	<b>\$9.56</b>	5,000	WUMS6X58FCPZ5B	L42390	<b>\$43.80</b>
5/8" x 6	Nickel	1,000	WUMS6X58FCPNT	L54375	<b>\$10.43</b>	5,000	WUMS6X58FCPN5B	L54380	<b>\$51.00</b>
5/8" x 7	Nickel	1,000	WUMS7X58CPNT	L46800	<b>\$14.48</b>	-	-	-	-



## Insert Bit Holder, Magnetic, One Touch Release

- Soft push on the button, the bit will shoot forward due to the internal spring for easy removal
- Stainless steel housing

Item #	Price per Each
WR0614176638	<b>\$10.99</b>



## Insert Bit Holder, Magnetic

- High energy magnet helps alleviate the problem of lost bits

Item #	Overall Length	Price per Each
WR0614176702	3"	<b>\$6.49</b>





**Shoots micropins  
and microbrads**

### MicroPinner/Bradder, 23 Gauge

- Auto adjust push for different lengths
- Lock-out to prevent dry firing
- Removable no mar tip; belt hook
- Steel driver blade; for longer life
- Rear exhaust with muffler
- Swivel adapter for hose connection

Item #	Gauge	Range	Capacity	Price per Each
WR11191W	23	Microbrads 7/8" - 1-3/8" Micropins 1/2" - 1"	120 Pins or Brads	<b>\$224.99</b>

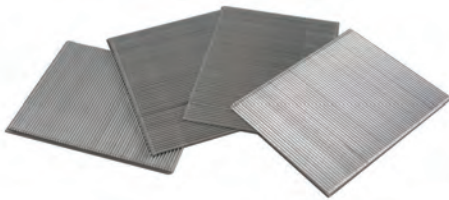

### Micro Brads, 23 Gauge

- Applications: Cabinet doors, light trim, carvings and ornamentals and picture frames

Length	Item #	Box Qty	Price per Box
7/8"	WRN23088B	10,000	<b>\$36.30</b>
1"	WRN23100B	10,000	<b>\$37.91</b>
1-3/16"	WRN23119B	10,000	<b>\$38.75</b>
1-3/8"	WRN23138B	10,000	<b>\$40.98</b>



### Micro Pins, 23 Gauge

- Applications: Cabinet doors, light trim, carvings and ornamentals and picture frames

Length	Item #	Box Qty	Price per Box
1/2"	WRN23050F-10	10,000	<b>\$21.74</b>
5/8"	WRN23058F-10	10,000	<b>\$21.99</b>
3/4"	WRN23075F-10	10,000	<b>\$22.49</b>
1"	WRN23100F-10	10,000	<b>\$22.99</b>



**TOP SELLER!**

### Staples, 1/4" Narrow Crown, 18 Gauge

- Applications: Casebacks, pre-hung units, paneling, interior trim, drawers underlayment, door and window casings, cabinet assembly, lattice glue blocks, moldings and cabinet box assembly

Length	Item #	Box Qty	Price per Box
1/2"	WRS18050K	5,000	<b>\$14.99</b>
5/8"	WRS18063K	5,000	<b>\$15.52</b>
3/4"	WRS18075K	5,000	<b>\$16.50</b>
7/8"	WRS18088K	5,000	<b>\$18.72</b>
1"	WRS18100K	5,000	<b>\$20.87</b>
1-1/8"	WRS18113K	5,000	<b>\$23.32</b>
1-1/4"	WRS18125K	5,000	<b>\$24.75</b>
1-1/2"	WRS18150K	5,000	<b>\$28.39</b>

Random Orbit Air Sander, 5" & 6"



3 VACUUM OPTIONS IN 1!

Technical Data	
Maximum RPM	12,000 RPM, variable
Sound Level	78 dB(A)
Included Backup Pad	5" No Hole PSA
Orbit	3/32" or 3/16"
Working Pressure	90 psi
Weight	1.98 lbs
Warranty:	1-year limited

VACUUM OPTIONS:

**Non-Vac:** Turn dial to "C", use included 5" No Hole PSA backup pad.

**Self-Gen Vac:** Turn dial to "S", change to a vacuum pad and hook up dust collection kit.

**Central Vac:** Turn dial to "C", change to a vacuum pad and hook up to your vacuum system.

**NOTE:** Vacuum pads and dust collection kit sold separately.

LOW NOISE!  
LOW VIBRATION!

SANDERS				
Item #	Size	Orbit	Attachment	Price per Each
WR5714001170	5"	3/32"	PSA	\$160.00
WR5714002170	5"	3/16"		
WR5714004180	6"	3/32"		
WR5714005180	6"	3/16"		



3/32" Orbit for fine finish sanding, less stock removal.



3/16" Orbit for general purpose sanding.

BACKUP PADS				
Item #	Size	Attachment	Holes	Price per Each
WR8521125116961	5"	Hook & Loop	5 Hole	\$16.35
WR8521125117961		Hook & Loop	Multi-Hole	\$21.49
WR8521125110961		Hook & Loop	No Hole	\$16.35
WR8521125020961		PSA	5 Hole	\$16.35
WR8521125010961		PSA	No Hole	\$16.35
WR8521120117961	6"	Hook & Loop	Multi-Hole	\$21.49
WR8521150110961		Hook & Loop	No Hole	\$16.35



DUST COLLECTION KIT		
Item #	Description	Price per Each
WR5704000001	Dust Collection Kit	\$16.49



**SOFT - TOUCH LEVER**

Easy on/off and speed control

**VACUUM CONTROL DIAL**

For switching vacuum options to meet your dust extraction needs

**REAR EXHAUST**

Allows connection to dust suction hoses

**AIR/VARIABLE SPEED REGULATOR**

Easy adjustment for controlled and comfortable operation

**ERGO PALM SHAPE**

Ergonomically developed for operator comfort

**COMPOSITE HOUSING**

Composite blend housing is lightweight and impact resistant

**ECCENTRIC (DUAL ACTION) PATTERN**

Uniform finishing even when operated by users of any experience level

**INTEGRATED MUFFLER**

Muffling system reduces sound levels as low as 78 dB(A)

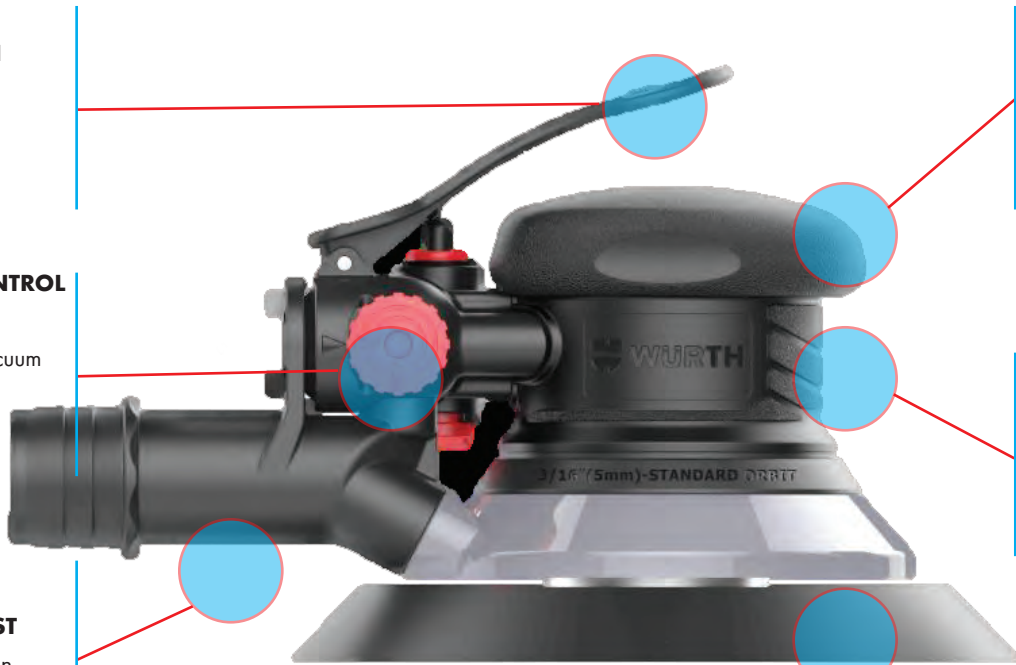



Other sizes, grits & backing available

## Aluminum Oxide Paper Discs

- No Hole PSA
- Open coat design reduces heat and loading
- Latex coated paper discs improve moisture resistance and flexibility
- C weight paper outperforms competitive products
- For universal and fine sanding as well as stock removal
- Sold in boxes of 100 discs

Grit	5" Disc Item #	Price per Box	6" Disc Item #	Price per Box
100	WR8507342210961	<b>\$18.30</b>	WR8507343210961	<b>\$24.99</b>
120	WR8507342212961	<b>\$18.30</b>	WR8507343212961	<b>\$24.99</b>
150	WR8507342215961	<b>\$18.30</b>	WR8507343215961	<b>\$24.99</b>
180	WR8507342218961	<b>\$18.30</b>	WR8507343218961	<b>\$24.99</b>



Other sizes, grits & backing available

## Aluminum Oxide Film Discs

- No Hole PSA
- Open grain reduces heat and loading
- Perfect for wet sanding applications
- Film backing outlasts paper
- Ideal for solid surface
- Sold in boxes of 100 discs

Grit	5" Disc Item #	Price per Box	6" Disc Item #	Price per Box
100	WR8506342210961	<b>\$24.60</b>	WR8506343210961	<b>\$35.90</b>
120	WR8506342212961	<b>\$24.60</b>	WR8506343212961	<b>\$35.90</b>
150	WR8506342215961	<b>\$24.60</b>	WR8506343215961	<b>\$35.90</b>
180	WR8506342218961	<b>\$24.60</b>	WR8506343218961	<b>\$35.90</b>

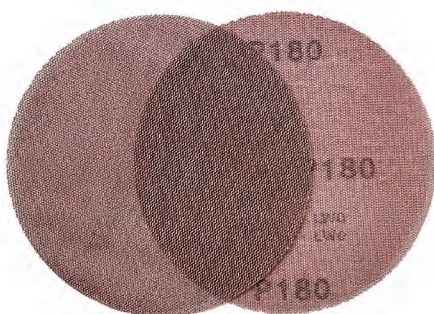

Other grits available

## Aluminum Oxide Net Discs

- Dust-free sanding allows clean and healthy work environment
- Full-surface dust extraction, combined with special abrasive coating method, prevents clogging
- Tear resistant due to sturdy net backing
- Sold in boxes of 50 discs

Grit	5" Disc Item #	Price per Box	6" Disc Item #	Price per Box
120	WRNET5120G	<b>\$21.95</b>	WRNET6120G	<b>\$29.05</b>
150	WRNET5150G	<b>\$21.95</b>	WRNET6150G	<b>\$29.05</b>
180	WRNET5180G	<b>\$21.95</b>	WRNET6180G	<b>\$29.05</b>
220	WRNET5220G	<b>\$21.95</b>	WRNET6220G	<b>\$29.05</b>

## Würth Workout Week 2024



Cut out in box makes it easy to tell when you need to re-order.

### Flexible 1 Sided Foam Sponge

- Aluminum oxide on flexible sponge backing – open coat
- Roll packaging in heavy duty cardboard package keeps sponges clean and dust free, ready to use
- Cut out in box makes it easy to tell when it is time to re-order
- Perforated sections make for easy tear-off
- Each sponge measures 4-1/2"W x 4-7/8" L

Packing: One 25 yard roll per box.

Sold In: Full roll/box quantities only.

Grit	Item #	Price per Box	Grit	Item #	Price per Box
P150	WR8507442115961	<b>\$48.49</b>	P280	WR8507442128961	<b>\$48.49</b>
P180	WR8507442118961	<b>\$48.49</b>	P320	WR8507442132961	<b>\$48.49</b>
P220	WR8507442122961	<b>\$48.49</b>	P400	WR8507442140961	<b>\$48.49</b>
P240	WR8507442124961	<b>\$48.49</b>			



### Color Coded Sanding Sponges, 1 Sided

- Aluminum Oxide
- Highly conformable
- Can be used wet or dry
- Sold by the box of 20 sponges

Color	Grit	Size	Item #	Price per Box
Purple	60 (Medium)	4-1/2" x 5-1/2"	WR0587089910	<b>\$13.00</b>
Blue	100 (Fine)	4-1/2" x 5-1/2"	WR0587099914	<b>\$13.00</b>
Green	180 (Superfine)	4-1/2" x 5-1/2"	WR0587099918	<b>\$13.00</b>
Orange	220 (Ultrafine)	4-1/2" x 5-1/2"	WR0587099919	<b>\$13.00</b>
Yellow	280 (Microfine)	4-1/2" x 5-1/2"	WR0587099922	<b>\$13.00</b>



### 2 & 4 Sided Sponges

- Perfect for scuff sanding and sealer sanding
- Flexible, non-loading aluminum oxide
- Sold by the box of 10 sponges

Item #	Type	Size	Price per Box
WR58701100696110	2-Sided	3-7/8"L x 4-3/4"W x 1/2"H	<b>\$6.20</b>
WR58701101096110	2-Sided	3-7/8"L x 4-3/4"W x 1/2"H	<b>\$6.20</b>
WR58701101896110	2-Sided	3-7/8"L x 4-3/4"W x 1/2"H	<b>\$6.20</b>
WR587010006961	Block (4-Sided)	3-7/8"L x 2-3/4"W x 1"H	<b>\$6.80</b>
WR587010010961	Block (4-Sided)	3-7/8"L x 2-3/4"W x 1"H	<b>\$6.80</b>
WR587010018961	Block (4-Sided)	3-7/8"L x 2-3/4"W x 1"H	<b>\$6.80</b>

## Würth Workout Week 2024

### Expanding Foam Sealant

- Airtight and water-resistant seal
- Weatherproof and reduces drafts
- Seals out air, moisture and pests
- Tack free in 10 minutes
- Foam can be cut, sanded and/or painted



Fills Voids Up to 1"



Fills Voids Up to 3"



Item #	Size	Price per Each
WR5983145300	12 oz	\$4.24

Item #	Size	Price per Each
WR5983146300	12 oz	\$4.24



### Ready-To-Use Joint Compound

- All purpose
- Lightweight
- Waterbased for simple cleanup
- Holds tight and dries fast

Item #	Size	Price per Each
WR5983000002	1 Quart	\$6.93
WR5983000004	1 Gallon	\$19.97

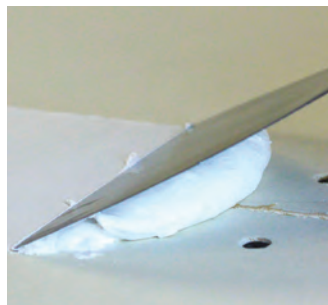

## Würth Workout Week 2024

### Fill & Finish Water Based Putty

Fill & Finish is a unique water-based multi-purpose wood and grain filler and can be used to mask small or large defects.

Accepts any pigment - water or oil based

- No VOC's
- Does not shrink, sink, crack, or fall out
- Can be used inside or outside
- Can be sanded easily to achieve a desired finished look
- Can be drilled, nailed, planed or sawed like ordinary wood
- Can be restored to original consistency with water
- High solid content and fast dry time



**16 oz. wide mouth container for easy putty knife access!**

Color	Name	16 oz. Item #	Price per Each	Quart Item #	Price per Each
	Ash	WR0890303500	<b>\$9.49</b>	WR0890303512	<b>\$16.49</b>
	Rosewood	WR0890303501	<b>\$9.49</b>	WR0890303513	<b>\$16.49</b>
	Cherry/Alder	WR0890303502	<b>\$9.49</b>	WR0890303514	<b>\$16.49</b>
	Mahogany/Braz Cherry	WR0890303503	<b>\$9.49</b>	WR0890303515	<b>\$16.49</b>
	Maple/Beech/Pine	WR0890303504	<b>\$9.49</b>	WR0890303516	<b>\$16.49</b>
	Natural/Tint Base	WR0890303505	<b>\$9.49</b>	WR0890303517	<b>\$16.49</b>
	Red Oak	WR0890303506	<b>\$9.49</b>	WR0890303518	<b>\$16.49</b>
	Ebony	WR0890303507	<b>\$9.49</b>	WR0890303519	<b>\$16.49</b>
	Walnut	WR0890303508	<b>\$9.49</b>	WR0890303520	<b>\$16.49</b>
	White	WR0890303509	<b>\$9.49</b>	WR0890303521	<b>\$16.49</b>
	White Oak	WR0890303510	<b>\$9.49</b>	WR0890303522	<b>\$16.49</b>
	Alder	WR0890303511	<b>\$9.49</b>	WR0890303523	<b>\$16.49</b>

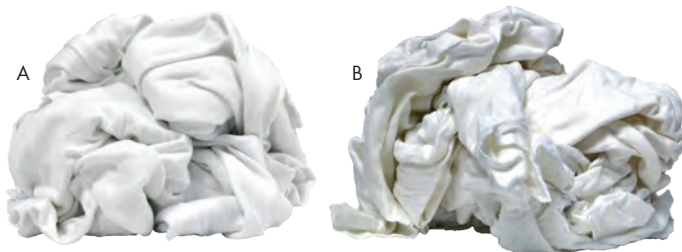

### White Cotton Knit Rags

- Washed, bleached and processed for absorbency
- Usable size of 12" x 12" and up
- Use for staining, painting, cleaning and more

	Item #	Color	Box Size	With Punchout	With Perforated Handles	Price per Box
<b>White Cotton Knit Rags, New Material</b>						
A	WR0899800300	White	#5	Yes	No	<b>\$13.99</b>
	WR0899800301	White	#10	Yes	No	<b>\$24.99</b>
	WR0899800302	White	#25	Yes	Yes	<b>\$59.99</b>
	WR0899800303	White	#50	No	No	<b>\$117.88</b>
<b>White Cotton Knit Rags, Recycled/Reclaimed Material</b>						
B	WR0899800401	White	#5	Yes	No	<b>\$9.99</b>
	WR0899800402	White	#10	Yes	No	<b>\$18.49</b>
	WR0899800403	White	#25	Yes	Yes	<b>\$44.99</b>



## Mixing Cups and Lids

- Disposable cups for mixing and storing paint materials and stains
- Will not deteriorate when using Acetone, Lacquer Thinner, Denatured Alcohol, Catalysts, Hardeners and Reducers in them
- Each size cup features a red 10% mark which can aid the user in measuring and a 20% red mark in case user needs room to add reducers
- Integrated mixing scales for balancing Paint, Hardener, Thinner quantities (1:1, 2:1, 3:1, 4:1 and 5:1)
- Lids sold separately

Packing & Sold In: Each.

NOTE: Please use paint manufacture recommendations for ratios.

Item #	Size	Price per Each
<b>MIXING CUPS ONLY</b>		
WRMIXCUP-PT	Pint	<b>\$0.36</b>
WRMIXCUP-QT	Quart	<b>\$0.52</b>
WRMIXCUP-2.5QT	2.5 Quart	<b>\$1.09</b>
WRMIXCUP-5QT	5 Quart	<b>\$2.09</b>
<b>MIXING CUP LIDS ONLY</b>		
WRMIXCUPLID-PT	Pint	<b>\$0.17</b>
WRMIXCUPLID-QT	Quart	<b>\$0.25</b>
WRMIXCUPLID-2.5QT	2.5 Quart	<b>\$0.45</b>
WRMIXCUPLID-5QT	5 Quart	<b>\$0.89</b>



## Paint Strainers

- Disposable screen for filtering varnishes, paints, primers, chemicals and other liquids
- Color-coded system for simple visual identification of mesh size
- Packing & Sold In: Full sleeve quantities

Item #	Micron	Color	Sleeve Qty	Price per Each
WRSTRAIN-XFINE	Extra Fine, 125µ	Blue	125 EA	<b>\$0.10</b>
WRSTRAIN-FINE	Fine, 190µ	Yellow	125 EA	<b>\$0.10</b>
WRSTRAIN-MED	Medium, 260µ	Orange	125 EA	<b>\$0.10</b>



## Stain Pads

- Fine terry stain pads with chemical resistant sponge inside
- Compatible with all stains; absorbent and washable

Packing & Sold In: Full pack quantities as shown below.

Item #	Size	Pack Qty	Price per Each
WR0899044120	4" x 4" x 1"	12 EA	<b>\$1.39</b>





## PX3 Plus Hand Cleaner Silicone & Solvent Free

- For extreme soiling such as paints, inks, adhesives, lacquers and sealants
- No greasy residue

Item #	Price per Each
WR0893901001	<b>\$8.49</b>



## Disposable Nitrile Gloves

- Powder free
- Sold in box quantities as noted below

Item #	Color	Size	Box Qty	Price per Box
<b>6 Mil Thickness</b>				
WR0899470398	Black	Medium	100 Each	<b>\$9.99</b>
WR0899470399	Black	Large	100 Each	<b>\$9.99</b>
WR0899470400	Black	Extra Large	100 Each	<b>\$9.99</b>
<b>8 Mil Thickness</b>				
WR0899970911	Orange	Medium	100 Each	<b>\$12.99</b>
WR0899970912	Orange	Large	100 Each	<b>\$12.99</b>
WR0899970913	Orange	Extra Large	100 Each	<b>\$12.99</b>
WR0899970914	Orange	2 Extra Large	100 Each	<b>\$12.99</b>



**TOP  
SELLER!**

## TigerFlex Light

- Used in light to medium work requiring a good grip and a high degree of flexibility
- Ideally suited for installation, workshop, packaging and assembly
- Optimal for freight forwarding, transport and sorting tasks

Packing and Sold: 12 pair per package. Available any quantity of pairs.



Item #	Size	Gauge	Glove Material	Coating Material	Cuff Style	Price per Pair
WR0899411118	8 (M)	18	Nylon	Nitrile Foam	Knit Wrist	<b>\$2.49</b>
WR0899411119	9 (L)	18	Nylon	Nitrile Foam	Knit Wrist	<b>\$2.49</b>
WR0899411120	10 (XL)	18	Nylon	Nitrile Foam	Knit Wrist	<b>\$2.49</b>
WR0899411121	11 (2 XL)	18	Nylon	Nitrile Foam	Knit Wrist	<b>\$2.49</b>



### Single Magnifying Readers

- Scratch resistant polycarbonate lens provides 99% UVA/B/C protection
- Integrated nose piece
- Wrap-around unilens for full panoramic view

Item #	Lens Color	Anti-Fog	Scratch Resistant	Adjustable	Diopter	Price per Each
WR0899100001	Clear	No	Yes	No	+1.5	<b>\$7.99</b>
WR0899100002	Clear	No	Yes	No	+2.0	<b>\$7.99</b>
WR0899100003	Clear	No	Yes	No	+2.5	<b>\$7.99</b>



### Safety Glasses, Over-The-Glass

- Lightweight and economical, vented temples for added comfort
- 99% UV protection; exceeds ANSI Z87.1-2003

Item #	Lens Color	Anti-fog	Scratch Resistant	Adjustable	Price per Each
WR0899103125	Clear	No	Yes	No	<b>\$2.69</b>



### Safety Glasses, Lightweight

- Integrated nose piece
- Exceeds ANSI Z87.1 High Impact Requirements

Item #	Lens Color	Anti-Fog	Scratch Resistant	Adjustable	Price per Each
WR0899103200	Clear	No	Yes	No	<b>\$2.39</b>
WR899103202	Clear	Yes	Yes	No	<b>\$2.89</b>



### Safety Glasses, Foam Lined

- Removable flame resistant foam padding helps limit eye exposure to dust and particles
- Exceeds ANSI Z87.1 High Impact Requirements

Item #	Lens Color	Anti-Fog	Scratch Resistant	Adjustable	Price per Each
WR899103218	Clear	Yes	Yes	No	<b>\$4.99</b>



## Foam Ear Plugs, NRR 32dB

- Soft, non-allergenic foam product with smooth outer comfort surface
- Brightly colored for easy compliance checks
- 1 pair per polybag, 200 pair per dispenser box
- Sold by box

Item #	Price per Box
WR0899300905	<b>\$25.00</b>



## Coveralls, Disposable

- Provides excellent protection against particles, dusts and liquid splashes
- Cuffed wrist, elastic waist, ankles and hood
- Soft fabric for increased freedom of movement and comfort while still being tear and abrasion-resistant
- Anti-static and lint-free

Size	Item #	Price per Each
M	WR0899021212	<b>\$5.74</b>
L	WR0899021213	<b>\$5.74</b>
XL	WR0899021214	<b>\$5.74</b>
2XL	WR0899021215	<b>\$5.74</b>
3XL	WR0899021216	<b>\$5.99</b>



## N95 Respirator, No Valve, NIOSH Approved

- Provides at least 95% filtration efficiency against certain non-oil based particles
- Durable, molded double-shell construction for long life
- Electrostatically-charged filter media provides low breathing resistance
- Latex-free, staple-free head straps for comfort and safety
- Contoured aluminum nose-clip provides greater comfort and helps reduce potential fogging
- Soft foam inner nose cushion
- Sold by box of 2 masks

Item #	Price per Mask
WR1899081730	<b>\$0.84</b>



## N95 Respirator, With Valve, NIOSH Approved

- NIOSH certified to have a filter efficiency level of 95% or greater against non-oil particulate aerosols
- Oversized valve opens more easily to expel hot air for cool comfort
- Adjustable nose band to adjust the mask to the shape of your face
- Elastic head straps are tear-resistant

Packing and Sold in: Multiples of 10.

Item #	Price per Mask
WR0899120002	<b>\$1.64</b>

## Disposable Respirator Kit, Complete Unit

### "P" - Level non-degrading filter

does not require change-out at end of every shift. Reduces use cost by 50-100%

**Full-elastomer nose bridge and softer elastomer** for superior wearing comfort



**Rugged, engineering-grade ABS** plastic for frame and cartridges provide durability and trouble free use

- NIOSH OV/P95 Approved
- OV/P95 filter provides at least 95% filtration efficiency against organic vapor, solid and liquid aerosols, including oil based aerosols
- Usable with isocyanates in accordance with label warnings and limitations
- Completely assembled and individually packed in resealable foil bags
- Includes Hygiene Guard for clean storage and product protection

NOTE: Cartridges are not replaceable; filter pads are.

Item #	Description	Sold in Multiples of	Price per Each
WR1899871501	1/2 Mask Respirator, Medium	1 Each	<b>\$18.99</b>
WR1899871502	1/2 Mask Respirator, Large	1 Each	<b>\$18.99</b>
WR1899871916	Filter Pads	10 Each	<b>\$2.09</b>
WR1899871620	Filter Pad Retainer	20 Each	<b>\$1.29</b>



### Hygiene Guard / Shape Retainer Insert

keeps respirator clean and prevents damage to the face-piece



### Reusable Foil Storage

**Bag** plus individually wrapped respirator help assure best respirator life

## Würth Workout Week 2024

### Professional Respirator Kits Complete Units

#### BOTH STYLES FEATURE:

- Silicone half mask for greater softness, comfort and durability
- Completely assembled and individually packed in resealable foil bags
- Heavy duty adjustable head straps for comfort and safety
- Compatible with a variety of protective eyewear and hearing protection



Both styles include **Hygiene Guard / Shape Retainer Insert** that keeps respirator clean and prevents damage to the facepiece



### Pancake Style, Complete Unit

- NIOSH OV/P95 Approved for respiratory protection against a wide range of oil and non-oil based particulate contaminants
- Provides at least 99.97% filtration efficiency against certain particles such as lead, asbestos, cadmium, arsenic and MDA
- Layer of activated carbon provides comfort relief against nuisance levels of organic vapor, acid gas
- Replaceable pancake particulate filters

Item #	Description	Sold in Multiples of	Price per Each
WR1899089290	1/2 Mask Respirator Kit, Medium	1 Each	<b>\$29.99</b>
WR1899089390	1/2 Mask Respirator Kit, Large	1 Each	<b>\$29.99</b>
WR189908200	Replacement Pancake Particulate Filters	2 Each	<b>\$3.99</b>

Reusable Foil Storage Bag helps assure best respirator life

**Includes 4 each pancake particulate filters**



### Cartridge Style, Complete Unit

- NIOSH OV/P95 approved for Organic Vapours plus solid and oil aerosols
- Soft foam nose cushion for more comfort
- Replaceable cartridges and particulate filters

Item #	Description	Sold in Multiples of	Price per Each
WR1899089291	1/2 Mask Respirator Kit, Medium	1 Each	<b>\$27.99</b>
WR1899089391	1/2 Mask Respirator Kit, Large	1 Each	<b>\$27.99</b>
WR1899871481	Replacement Organic Vapor Cartridge	2 Each	<b>\$3.99</b>
WR1899871916	Replacement Particulate Filter Pads	10 Each	<b>\$2.09</b>
WR1899871620	Replacement Particulate Filters Pad Retainers	20 Each	<b>\$1.29</b>

Reusable Foil Storage Bag helps assure best respirator life



## Masking Tape, General Purpose

A general purpose masking tape coated with a natural rubber adhesive.

- Crepe paper backing and natural rubber adhesive
- Great adhesion and holding properties
- Good temperature resistance
- Excellent appearance and resists breakage during application

### Applications:

General purpose bundling, packaging, protecting and splicing.  
Sold In: Each.

Item #	Size	Thickness	Tensile Strength	Adhesion	Elongation	Max Temp	Price per Each
WR0985010403	3/4" x 60yds	4.9 mil	19 lbs/in	22 oz/in	8%	176° F (30 minutes)	<b>\$1.69</b>
WR0985010404	1" x 60yds	4.9 mil	19 lbs/in	22 oz/in	8%	176° F (30 minutes)	<b>\$2.29</b>
WR0985010405	1-1/2" x 60yds	4.9 mil	19 lbs/in	22 oz/in	8%	176° F (30 minutes)	<b>\$3.29</b>
WR0985010406	2" x 60yds	4.9 mil	19 lbs/in	22 oz/in	8%	176° F (30 minutes)	<b>\$4.59</b>



## Masking Tape, Blue Painter's

Blue painters masking tape with 14 day UV resistance.

- Crepe paper backing and natural rubber adhesive
- Excellent choice for painted walls, trim, woodwork, interior masking of windows, glass and metal or wherever masking is exposed to weather/outdoor conditions
- Easy clean removal from most surfaces for up to 14 days
- UV resistance & stability for 14 days

### Applications:

Indoor painting, automotive painting, resistor belting, splicing.  
Sold In: Each.

Item #	Size	Thickness	Tensile Strength	Adhesion	Elongation	Max Temp	Price per Each
WR0992010400	3/4" x 60yds	4.9 mil	20 lbs/in	17 oz/in	8%	176° F (30 minutes)	<b>\$3.39</b>
WR0992010401	1" x 60yds	4.9 mil	20 lbs/in	17 oz/in	8%	176° F (30 minutes)	<b>\$4.49</b>
WR0992010402	1-1/2" x 60yds	4.9 mil	20 lbs/in	17 oz/in	8%	176° F (30 minutes)	<b>\$6.59</b>
WR0992010403	2" x 60yds	4.9 mil	20 lbs/in	17 oz/in	8%	176° F (30 minutes)	<b>\$8.09</b>



## Carton Sealing Tape

### ECONOMY GRADE

- An economy grade polypropylene film packaging tape coated with a water based acrylic adhesive

### PRODUCTION GRADE

- A production grade polypropylene film tape coated with a hot melt rubber adhesive system perfect for carton sealing and light bundling

### HIGH PERFORMANCE GRADE

- A high performance polypropylene packaging tape coated with a solvent acrylic adhesive

Packing: 6 rolls per sleeve, 36 rolls per case.

Sold In: Each.

Item #	Type	Size	Thickness	Tensile Strength	Adhesion	Elongation	Temp Range	Price per Each
WR0985010400	Economy	2" x 110yds	1.6 mil	17 lbs/in	16 oz/in	150%	25° to 104° F	<b>\$2.69</b>
WR0985010401	Production	2" x 110yds	1.83 mil	26 lbs/in	47 oz/in	165%	30° to 140° F	<b>\$3.48</b>
WR0985010402	High Performance	2" x 55yds	3.5 mil	37 lbs/in	28 oz/in	140%	-4° to 122° F	<b>\$4.82</b>

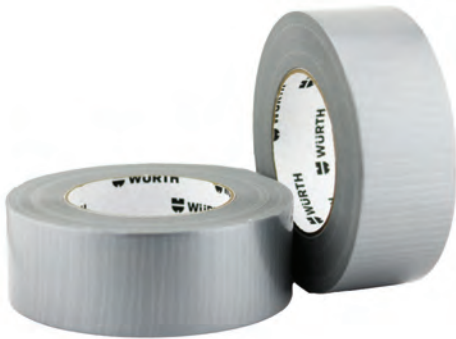

## Duct Tape

### ECONOMY GRADE

- A general purpose, economy grade poly coated cloth tape with a natural rubber adhesive

### UTILITY GRADE

- A general purpose, utility grade poly coated waterproof cloth tape with a natural rubber adhesive

Packing: 6 rolls per sleeve, 24 rolls per case.

Sold In: Each.

Item #	Type	Size	Thickness	Tensile Strength	Adhesion	Elongation	Temp Range	Price per Each
WR0985010416	Economy	2" x 60yds	7 mil	21 lbs/in	65 oz/in	19%	40° to 200° F	<b>\$8.98</b>
WR0985010417	Utility	2" x 60yds	8 mil	26 lbs/in	54 oz/in	20%	32° to 200°F	<b>\$10.94</b>

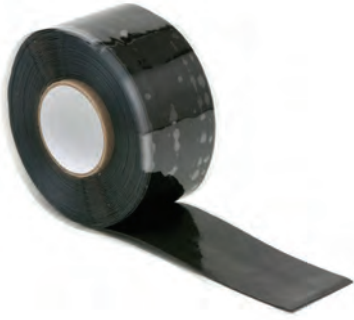

### Silicone Tape, Self-Fusing

- Highly resistant, self-welding silicone tape for instant repairs and sealing applications
- Water and air-tight in seconds
- Functions even on damp, oily surfaces or underwater

NOTE: Tape is not self-adhesive and is only intended for temporary repairs, not reusable

Item #	Description	Price per Each
WR985077200-B	1" x 10', Black	<b>\$4.74</b>



### Professional Grade Electrical Tape

- Aggressive rubber-resin adhesive with good aging characteristics
- Plasticized polyvinyl chloride film backing
- No flagging or deterioration even under temperatures as high as 176° F
- UL listed and CSA certified

Item #	Roll Size	Price per Each
WR985201	3/4"W x 20 yds.	<b>\$0.74</b>

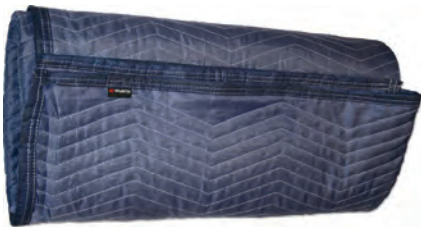

### Furniture Pads

- Premium heavy duty polyester filler with zig-zag stitching
- Woven edge for added strength

Item #	Blanket Size	Price per Each
WRFP9	72" x 80"	<b>\$15.09</b>



### Open Deck Dolly

- Carpet covered ends
- Wheels are 3" non-marking polypropylene and resist chemical and water absorption

Item #	Weight Capacity	Size	Price per Each
WR715931002	1,000 lbs.	25-1/2" L x 15-3/4" W x 5-1/2" H	<b>\$42.69</b>



### Closed Deck Dolly

- Solid deck design can be used with large or small items
- Wheels are 3" non-marking polypropylene and resist chemical and water absorption

Item #	Weight Capacity	Size	Price per Each
WR715931007	1,000 lbs.	23-5/8" L x 17-5/8" W x 5" H	<b>\$35.99</b>



## Würth Workout Week 2024



### Glass Cleaner

- Streak proof formula is safe for use on glass surfaces and plastics
- Foam clings to surface for greater cleaning power
- Ammonia free

Item #	Can Size	Price per Each
WR0890925	19 fl. oz.	<b>\$4.99</b>



### Super Spray All, Eco Friendly Multi-Purpose Cleaner

- A highly effective multi-purpose cleaner that quickly and easily removes a variety of dirt, grease, and general soils
- Ideal for use on any hard washable hard surfaces, including: vinyl, painted metal, porcelain, fiberglass, and plastic (not for use on glass)
- Meets all low VOC requirements; 50 state compliant
- Excellent spot remover
- No dilution needed - ready to use

Item #	Size	Price per Each
WR0890909	33 fl. oz.	<b>\$6.99</b>
WR89090904	1 Gallon	<b>\$17.99</b>
WR890909020	5 Gallon	<b>\$74.99</b>

Great for laminate, melamine and thermofoil doors



### MPL 50 Multi-Purpose Lubricant, Silicone Free

MPL 50 works hard and digs deep. Unlike ordinary penetrating oils, this specially designed, state-of-the-art formula goes to work FAST and loosens almost any part frozen by rust, corrosion, carbon, varnish, gum or paint. Cleans dirty, corroded machinery and aids in disassembly of equipment and pipe joints. It may also be used for cleaning yard tools, shop equipment and hand tools.

<b>% VOC</b>	10% VOC
<b>Evaporation Rate</b>	>151
<b>Flammability:</b>	Extremely Flammable Aerosol Can
<b>Spray Pattern</b>	Tight Mist to Stream

Item #	Net Weight	Price per Each
WR0893055470	10 oz	<b>\$7.49</b>

50 STATE COMPLIANT



LOOSEN



LUBRICATE



CLEAN



PREVENT



REPEL



## 8 IN 1 Screwdriver with LED Worklight

### Magazine Screwdriver

- Seven of the most widely-used bits

### LED Worklight

- Water-resistant and extra rugged to endure any environment
- Includes 3 AAA batteries

Item #	Price per Each
WR0988122500	<b>\$23.99</b>



7 powerful LED lights



**Magnetic end - place where you need for hands free work!**

**BUY NOW AND SAVE!**

**Pricing effective: 4/22 - 5/24/2024.** Reference promo code **LP2007** when placing your order with Customer Service. For online customers, enter **LP2007** in the promo code field of the shopping cart.



*Rhino*

# WORKOUT WEEK 2024

### Würth Louis and Company

895 Columbia Street  
 Brea, CA 92821  
 (714) 529-1771  
 (800) 422-4389  
 Fax: (800) 446-9452  
 www.wurthlac.com

### Other locations:

Anaheim, CA	Idaho Falls, ID	Post Falls, ID
Benton, AR	Lacey, WA	Salt Lake City, UT
Boise, ID	Las Vegas, NV	San Antonio, TX
Denver, CO	Oklahoma City, OK	San Marcos, CA
Grand Prairie, TX	Phoenix, AZ	St. George, UT
Houston, TX	Portland, OR	West Jordan, UT